

NOTES:
 1. REFER SHEET W1.5 FOR PROPOSED WATER SYSTEM.
 2. REFER TO SHEET WA.4.1 FOR EMERGENCY VEHICLE ACCESS PLAN.

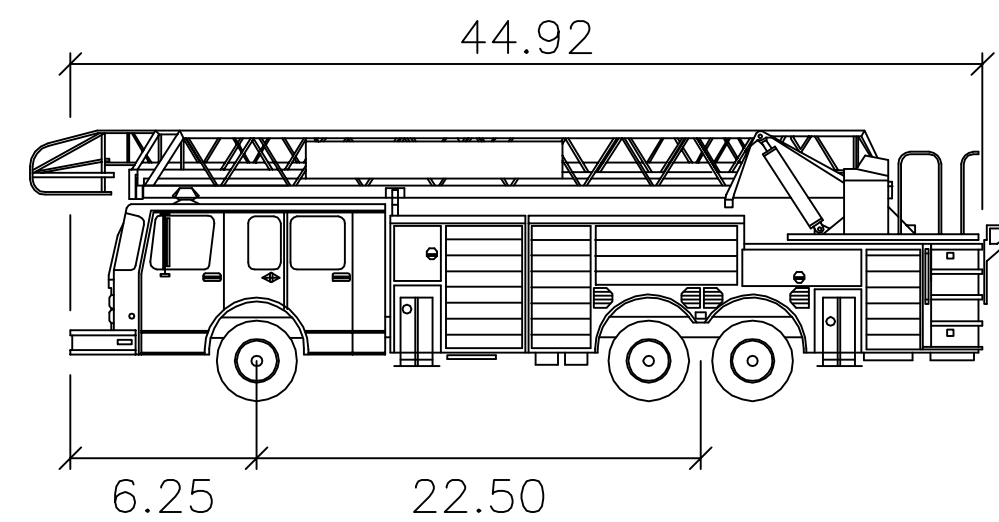

Menlo Park feet
 Width : 8.25
 Track : 8.25
 Lock to Lock Time : 6.0
 Steering Angle : 25.4

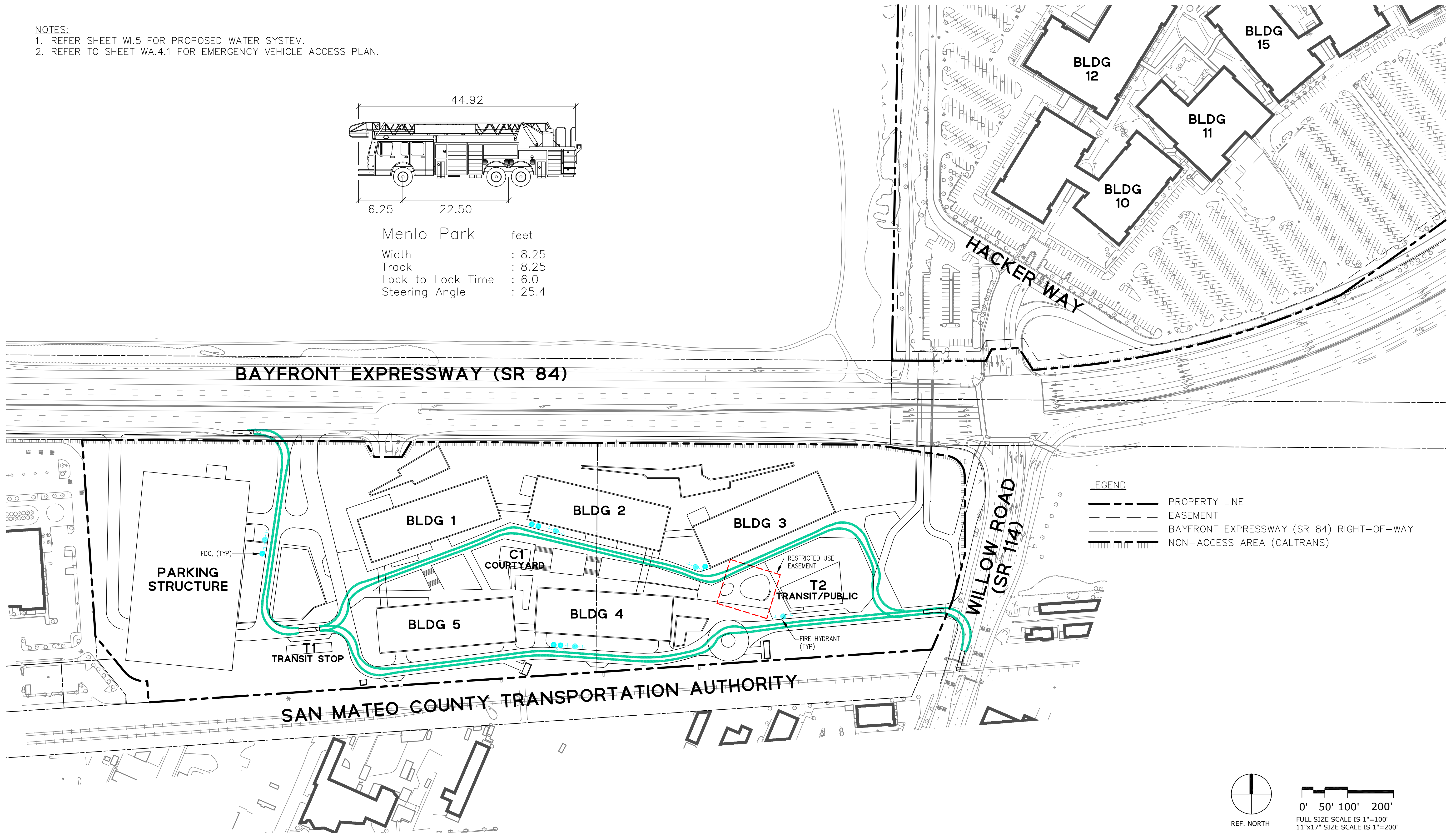

LEGEND
 - - - - - PROPERTY LINE
 - - - - - EASEMENT
 - - - - - BAYFRONT EXPRESSWAY (SR 84) RIGHT-OF-WAY
 ||||| NON-ACCESS AREA (CALTRANS)

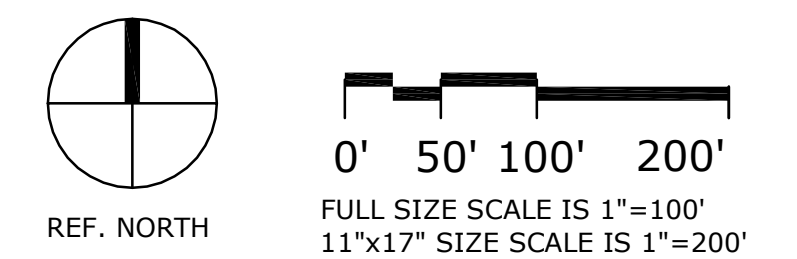

FACEBOOK @ MENLO PARK
 WEST CAMPUS

312 & 313 CONSTITUTION DR., MENLO PARK, CA



WA.4.1.3 EMERGENCY VEHICLE TURNING PLAN

August 5, 2011