

LICENSE AND COST SHARING AGREEMENT

This License and Cost Sharing Agreement (“**Agreement**”) is made this 27 day of September, 2016 (“**Effective Date**”) by and between the Left Bank Menlo Park (“**Participating Business**”), and the City of Menlo Park (“**City**”), alternatively referred to herein as a “**Party**” and collectively referred to herein as the “**Parties**”.

RECITALS

WHEREAS, local businesses expressed interest in a cost-sharing plan for the Santa Cruz Street Café Pilot Program (“**Program**”);

WHEREAS, the Program will be a semi-permanent expansion of the On-Street Dining Pilot Program from January 2015, open to businesses located in the central downtown area (“**Downtown**”);

WHEREAS, it was determined that the Program is consistent with the El Camino Real/Downtown Specific Plan to enhance the vibrancy of Downtown;

WHEREAS, on May 24, 2016, the City Council approved a design by Ian Moore Designs, Inc. and the cost-sharing requirements for the Program;

WHEREAS, several local businesses have submitted applications to participate in the Program;

WHEREAS, City staff has reviewed the applications and only approved applications which have a *de minimis* effect on parking, agree to comply with existing outdoor seating permit requirements, and agree to the cost-sharing plan; and

WHEREAS, the application submitted by Participating Business was reviewed and approved by City staff.

NOW, THEREFORE, the Parties agree as follows:

SECTION 1: Construction, Maintenance and Cost-Sharing of Improvement.

1.1 Construction. The City shall be responsible for design, construction, and installation of sidewalk improvements (“**Improvement**”) for the Program, as shown on **Exhibit A (“Final Plan”)**.

1.2 Location of Improvement. The installation of the Improvement shall be located in the in the public right-of-way immediately adjacent to the Participating Business as shown on the front page of **Exhibit A (“Final Plan”)**.

1.3 Cost-Sharing. The City shall be responsible for payment of eighty (80%) of the total cost of construction, and installation of the Improvement. The Participating Business shall be responsible for twenty (20%) of the total cost of construction and installation of

the Improvement and for any custom features desired beyond the base design. Attached as **Exhibit B (“Invoice”)**, is a cost breakdown indicating the total estimated amount owed by Participating Business. The Participating Business shall pay to the City its share of the cost as described herein and as shown on the Invoice within thirty (30) days of execution of this Agreement. If after completion of construction the actual final cost is more or less than the amount previously invoiced, then any overpayment shall be reimbursed to Participating Business or any underpayment shall be paid to the City within 30 days of receipt of notice.

1.4 Penalty for Delinquent/Non-Payment. In the event that the Participating Business does not submit payment of the Invoice to the City within the time set by Section 1.3, it will be required to pay a late payment penalty of five percent (5%) of the total delinquent payment and interest at a rate of ten percent (10%) per annum until the Invoice is paid in full.

1.5 Furnishings and Additional Improvements by Participating Business. All additional improvements made by Participating Business, such as lighting and/or outdoor heaters, shall be made at Participating Business’ sole cost and expense and shall be subject to City’s prior written approval, which approval shall not be unreasonably withheld. The Participating Business shall be responsible for providing any furnishings for its use of the Improvement, subject to City’s review and approval, not to be unreasonably withheld or delayed. At a minimum, Participating Business agrees to install furnishings and improvements to enhance the aesthetics of the Improvement as described in **Exhibit C (“Additional Improvements”)**. Such enhancements shall be completed/ installed when Participating Business commences use of the Improvement.

1.6 Maintenance and Repair. The Participating Business shall be responsible for the ongoing maintenance and repair of the Improvement and for any damage caused to the Improvement, including but not limited to, keeping the storm drain running through or adjacent to the Improvement free and clear of leaves, debris and blockages. If the Improvement is not properly maintained or damage is not repaired by the Participating Business, the City shall submit notice (“Maintenance/Repair Notice”) to the Participating Business specifying the maintenance and/or repair that must be completed. If the Participating Business does not comply with the Maintenance/Repair Notice within five (5) business days, the City may undertake and complete the required maintenance and/or repair. The Participating Business shall be responsible for reimbursing the City for the cost of such maintenance/repair performed by City.

1.7 Utilities. The Participating Business shall be responsible for payment of all utilities serving the Improvement, or to the extent the utilities are not separately metered and are paid for by the City, the parties shall determine a fair amount to be paid to the City annually to reimburse the City for the utilities serving the Improvement.

SECTION 2: License.

2.1 Grant of License. The City hereby grants to the Participating Business an exclusive license (“License”) upon, across, and over the Improvement Location for the purpose of utilizing the space for patrons of the Participating Business. The Parties agree

that this License does not grant or create in the Participating Business any fee, leasehold, easement or other interest or estate in land in the Improvement Location.

2.2 Permits. Participating Business shall and comply with any required City Administrative Permit for outdoor seating prior to any use of the Improvement requiring such permit.

2.3 Term. This Agreement shall become effective, and the obligations herein, commencing on the Effective Date and shall remain in effect for a term of five (5) years from the completion of the Improvement. Thereafter, the term shall continue on a month-to-month basis upon all of the terms and provisions herein, except that they City, upon approval of the City Council may require payment of a reasonable monthly or annual license fee for the continued use and enjoyment of the Improvement. Following the initial Term of this Agreement, the City may, with or without cause, revoke this License by service upon the Participating Business (or its heirs, successors and assigns) of a written notice of revocation ("Termination Notice") if the City determines that it is in the best interests of the public to do so. The Agreement shall terminate Ninety (90) days after City submits the Termination Notice. This Agreement and the License granted herein may also be terminated at any time upon written mutual agreement of the Parties.

2.5 Insurance. Participating Business shall maintain commercial business liability insurance coverage for use and maintenance of the Improvement, with limits of at least One Million Dollars (\$1,000,000) for each occurrence, naming the City as additional insured under such policy. Upon request, Participating Business shall provide the City with a certificate evidencing such insurance.

2.6 Indemnification. Participating Business shall indemnify, protect, defend and hold the City and its successors and assigns, and its agents, contractors, guests, and invitees, harmless from and against any and all claims, demands, actions, suits, losses, obligations, liens, proceedings, costs, expenses (including, without limitation, attorneys' fees and costs), judgments, orders, decrees, damages or liabilities of any type or kind arising out of or in any way connected with the Participating Business', including use by its employees and patrons, of the Improvement, as set forth in this Agreement; except to the extent such claims arise out of the gross negligence or willful misconduct of the City.

SECTION 3. Miscellaneous.

3.1 Notice. All notices required or permitted to be given under this Agreement must be in writing and mailed postage prepaid by certified or registered mail, return receipt requested, or by personal delivery or overnight courier to the appropriate address indicated below or at such other place(s) that either Party may designate in written notice to the other. Notices are deemed received upon delivery if personally served, one day after mailing if delivered via overnight courier, or two days after mailing if mailed as provided above.

City:

City of Menlo Park
Attn: Public Works Director
701 Laurel Street
Menlo Park, CA 94025

Participating Business:

Left Bank Menlo Park Brasserie
Attn: Mario Vega
820 Santa Cruz Ave
Menlo Park, CA 94025

3.2. Entire Agreement. This Agreement contains the entire understanding and agreement of the Parties relating to the rights granted and the obligations set forth in this Agreement. Any prior, contemporaneous or subsequent written or oral representations and modifications shall be of no force or effect, except an amendment in accordance with Section 3.3.

3.3 Amendment. This Agreement may only be amended in a writing executed by both Parties.

3.4 Severability. Should any provisions or portion hereof be declared to be invalid or in conflict with any law, the validity of all other provisions or portion of this Agreement shall remain unaffected and in full force and effect.

3.5 Governing Law and Venue. This Agreement shall be governed by and enforced in accordance with the laws of the State of California. The venue for any action related to this Agreement shall be the County of San Mateo, California.

3.6 Authority. Each Party to this Agreement represents and warrants to the other party that this Agreement is a binding obligation of the Party.

3.7 Waiver. Waiver by any Party of any of the provisions contained in this Agreement, or of the application thereof to any person by judgment or court order, shall in no way affect any of the other provisions of this Agreement, or the application thereof to any other person, and the same shall remain in full force and effect to the maximum extent possible.

3.8 Compliance with Laws. Participating Business shall comply with all applicable Federal, State and local laws, regulations and ordinances regarding the use of the Improvement, including but not limited to State Department of Alcohol and Beverage Control requirements for the service and consumption of alcohol and City Administrative Permit terms and conditions for participating business' use of the improvement.

3.9 Counterparts. This Agreement may be executed in counterparts, each of which, when taken together, shall constitute one and the same instrument.

3.10 Further Assurances. Each Party covenants, on behalf of itself and its successors and assigns, to take all actions and do all things, and to execute, with

acknowledgement or affidavit if required, any and all documents, instruments and writings as may be necessary or proper to achieve the purposes and objections of the Agreement.

3.11 Attorney Fees. In the event that any party to this Agreement commences any legal action or proceeding to enforce or interpret the provisions of this Agreement, the prevailing party in such action or proceeding shall be entitled to recover reasonable attorneys' fees and other costs incurred in that action or proceeding, in addition to any other relief to which the successful party may be entitled.

IN WITNESS WHEREOF, the Parties have hereunder subscribed their names the day and year indicated below.



CITY OF MENLO PARK,
a Municipal Corporation

By:  Charles Taylor for
Alex McIntyre, City Manager

Approved as to form:

William McClure, City Attorney

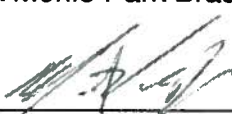
Left Bank Menlo Park Brasserie

By:  
Mario Vega, President/COO

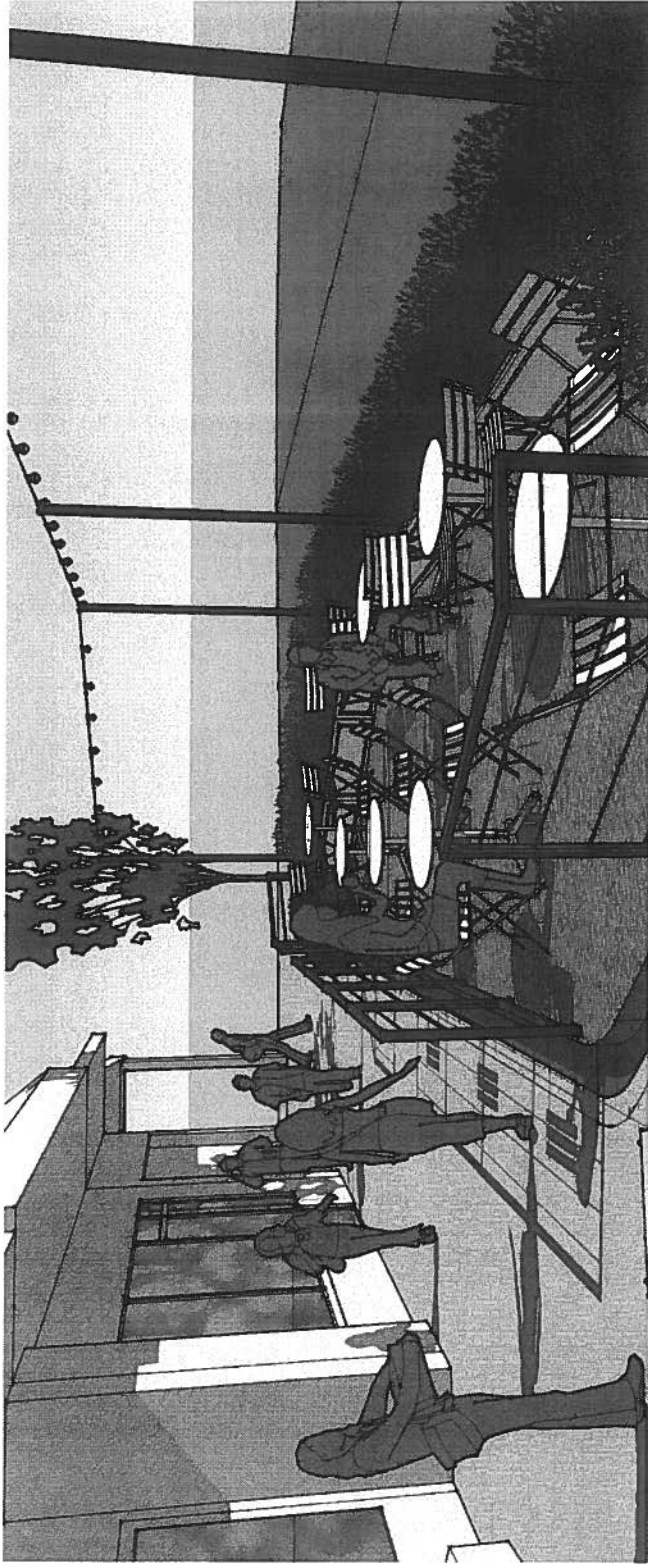

Left Bank



SHEET INDEX

- 001 - Cover
- 101 - Street Cafe Plan
- 102 - Existing Conditions
- 103 - Demolition Plan
- 201 - Concrete Platform Construction Plan
- 202 - Concrete Platform Details
- 301 - Cross-sections
- 401 - Drainage Grate Details
- 402 - Custom Railing & Light Pole Details
- 403 - Material Images



1503 Walnut Street
Berkeley, CA 94708

SANTA CRUZ STREET CAFE PROJECT: LEFT BANK LOCATION



001	15-07	Downtown Menlo Park Santa Cruz Ave. Street Cafes	Left Bank	Ian Moore Kyra Baldwin	Date: 8/10/2016 KB
-----	-------	---	-----------	---------------------------	-----------------------

SYMBOL LEGEND

EXISTING FEATURES

- ELECTRICAL OUTLET
- UTILITY BOX
- IRRIGATION BOX
- WATER METER
- WOOD CLAD STREET POLE
- BUS STOP

ELEVATION POINTS

- SITE ZERO ELEVATION
- EXISTING ELEVATION
- PROPOSED ELEVATION

SANTA CRUZ AVE.

DOYLE ST.

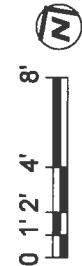
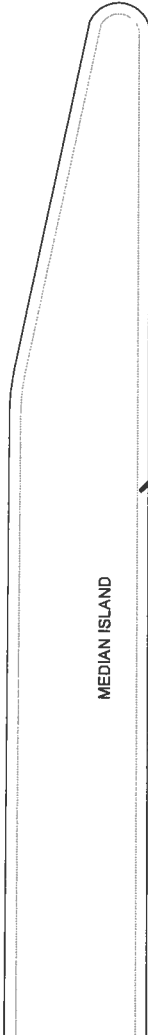

1323 Walnut Street
Berkeley, CA 94708

Date: 7/25/2016
KB

Scale: 1/4" = 1'-0"

Left Bank - Existing Conditions

Downtown Menlo Park
Santa Cruz Ave. Street Cafes

102 15-07

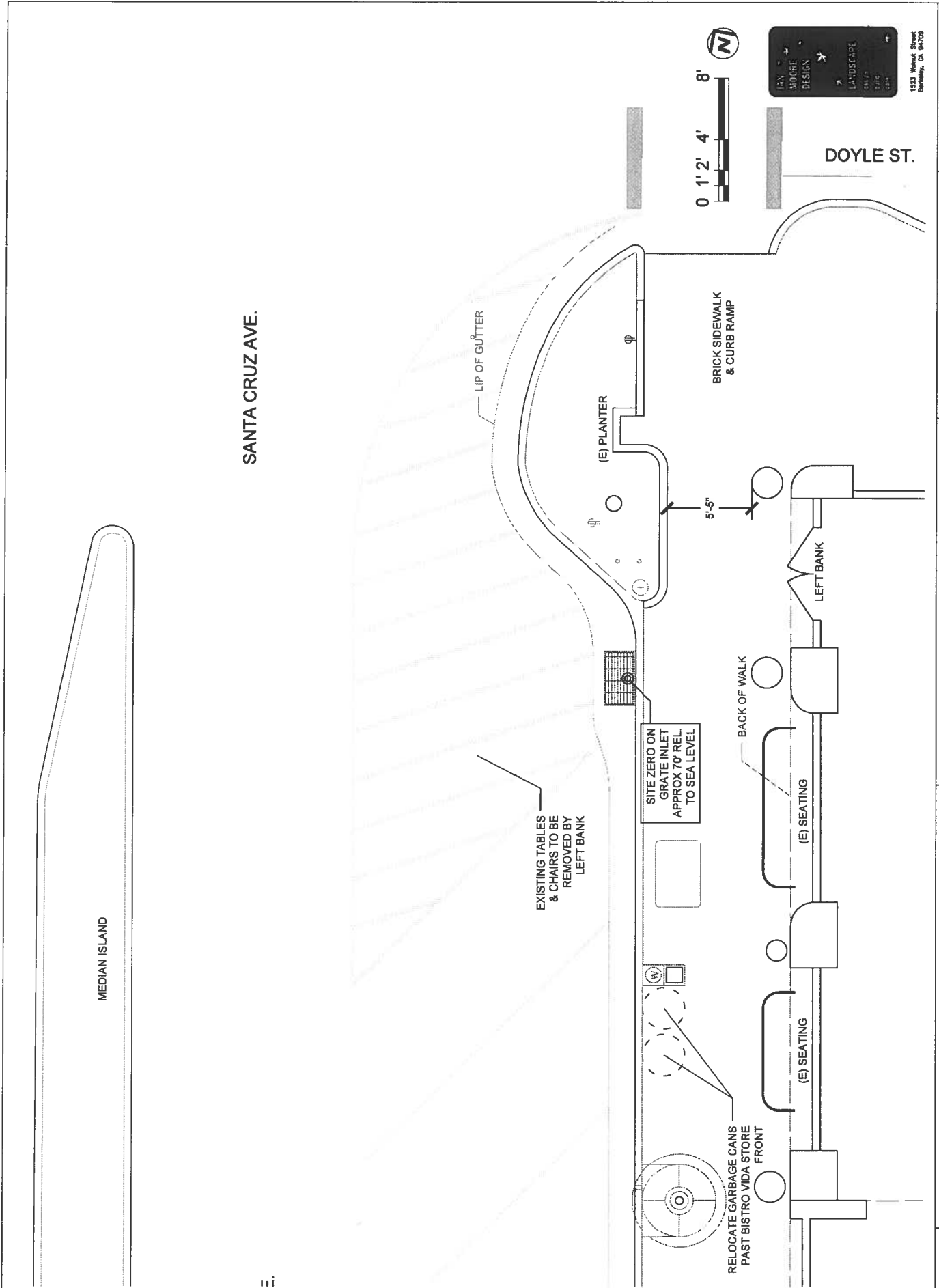

103	15-07	Downtown Menlo Park Santa Cruz Ave. Street Cafes	Left Bank - Demolition Plan	Scale: 1/4" = 1'-0"	Date: 8/10/2016 KB
-----	-------	---	-----------------------------	---------------------	-----------------------

Reinforcement for all street cafe platforms to include vertical doweling between existing asphalt and new concrete. Doweling to be placed by contractor per general specification and in accordance with basic layout provided on plans.

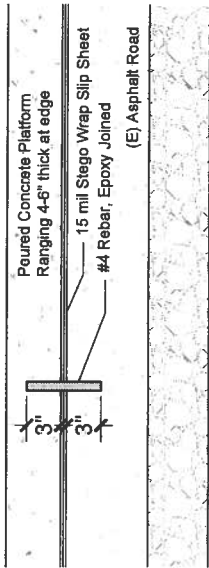

H Rebar Doweling Cross-Section
SCALE: 1-1/2" = 1'-0"

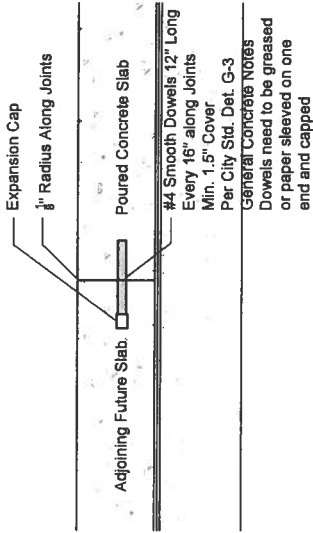

I Construction Joint Cross-Section
SCALE: 1-1/2" = 1'-0"

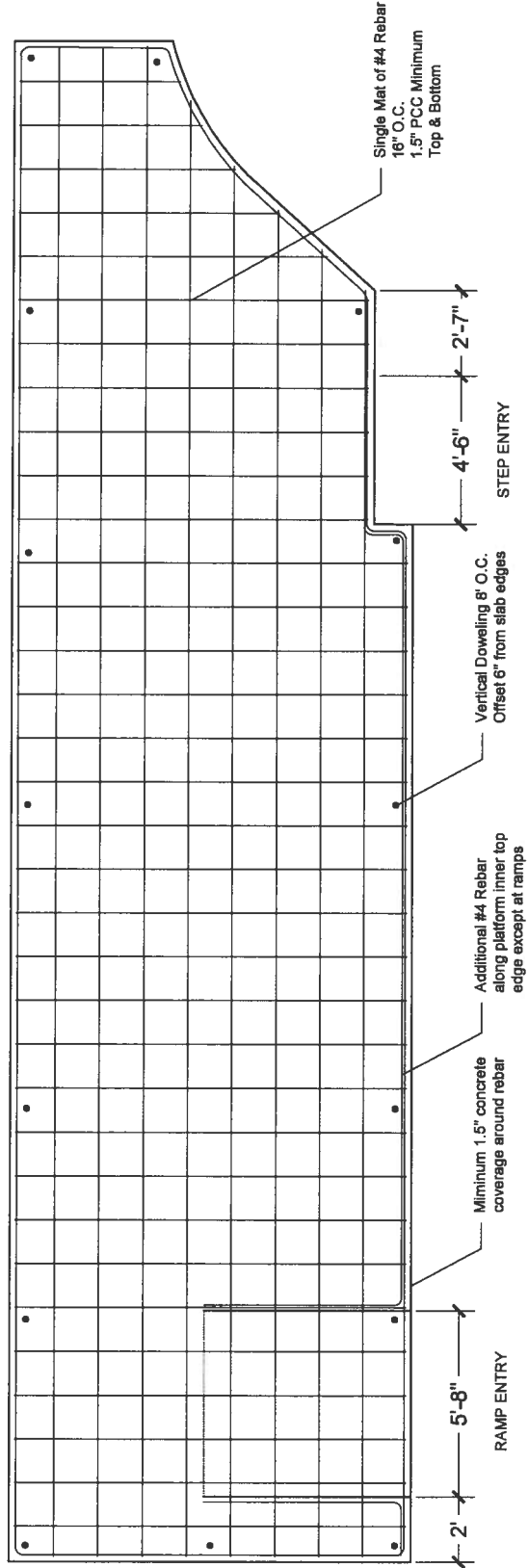

J Rebar Layout Plan
SCALE: 3/8" = 1'-0"



1033 Walnut Street
Berkeley, CA 94708

Date: 8/10/2016
KB

Scale: Varies

Left Bank - Concrete Details

Downtown Menlo Park
Santa Cruz Ave. Street Cafes

202 15-07

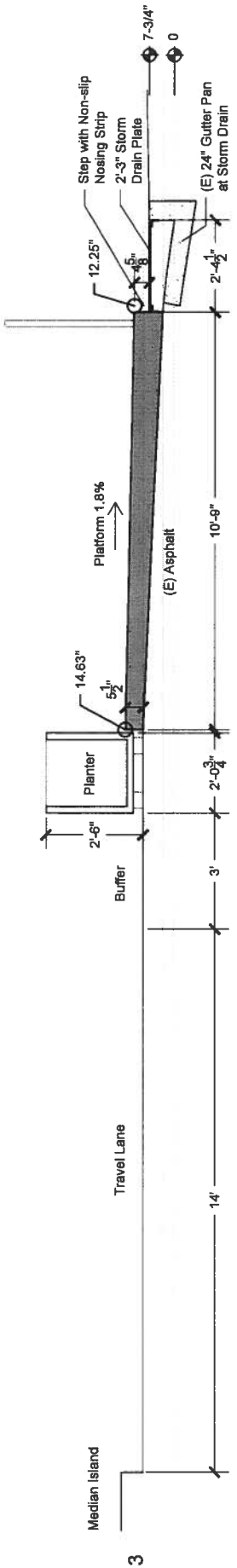
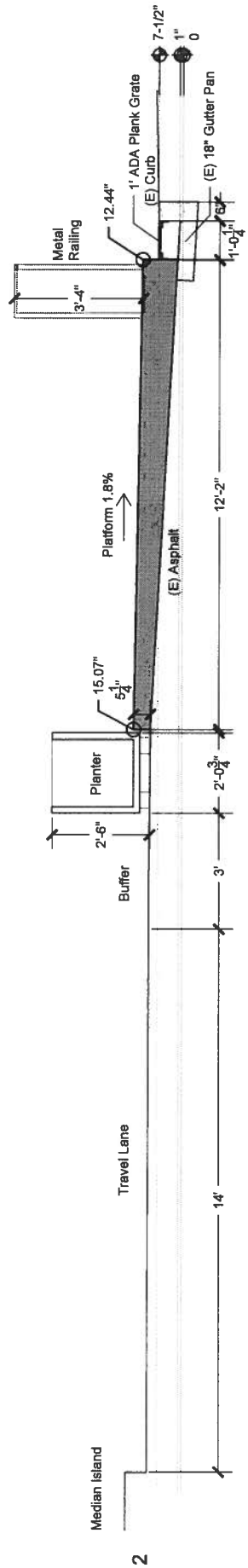
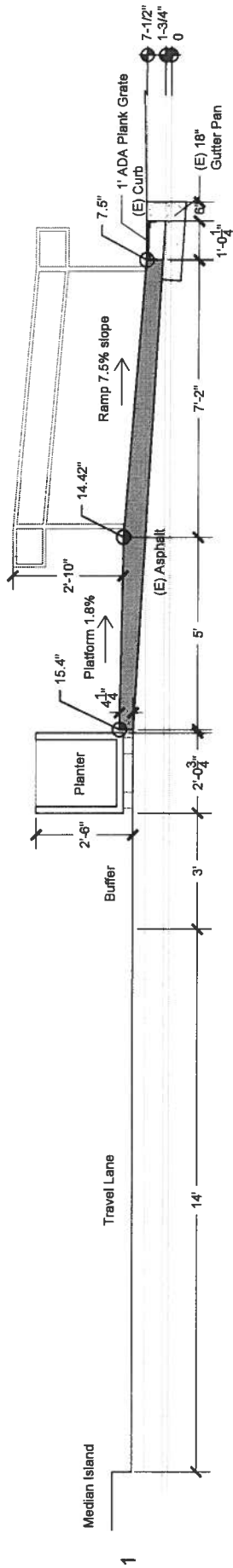

1333 Walnut Street
Berkeley, CA 94708

301

Downtown Menlo Park
Santa Cruz Ave. Street Cafes

Left Bank
Cross Sections

Scale: 1/2" = 1'-0"

Date: 8/10/2016
KB



Date: 8/2/2016
KB

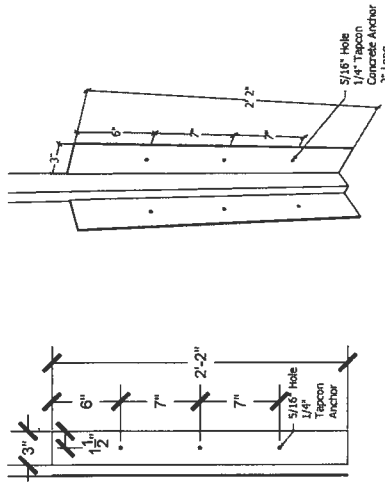

J Lighting Attachment to Planter Detail
SCALE: 1-1/2" = 1'-0" & N.T.S.

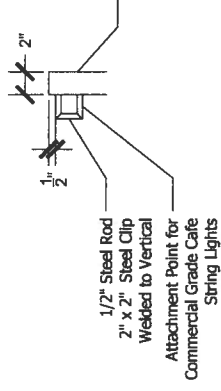

I Lighting Clip Detail
SCALE: 1-1/2" = 1'-0"

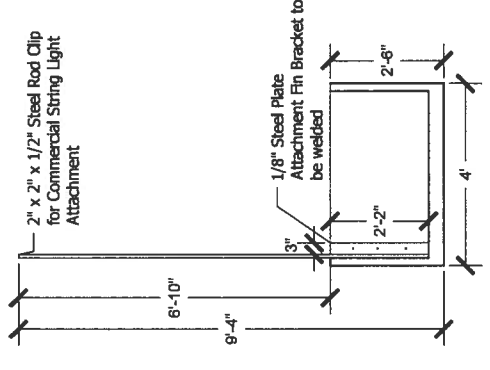

H Lighting Post Section-Elevation
SCALE: 1/2" = 1'-0"

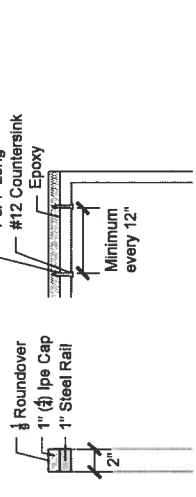

G Wood Rail Cap Detail
SCALE: 1-1/2" = 1'-0"

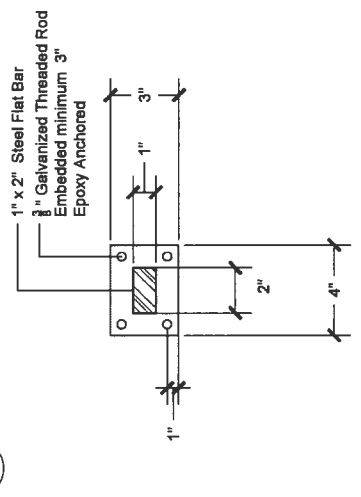

F Railing Foot Plan View
SCALE: 3" = 1'-0"

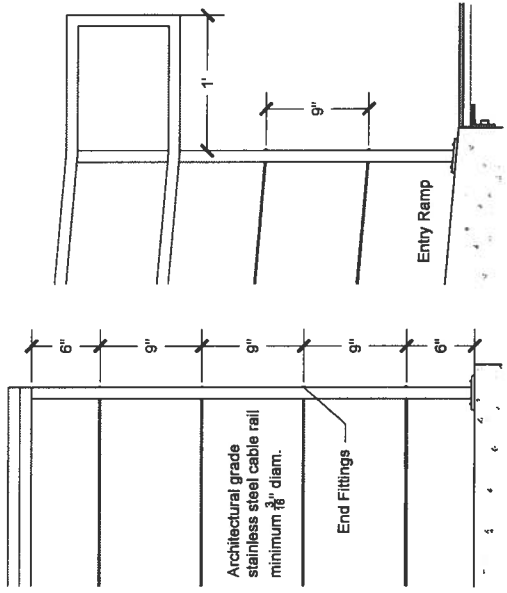

E Cable Rail Detail
SCALE: 1-1/2" = 1'-0"

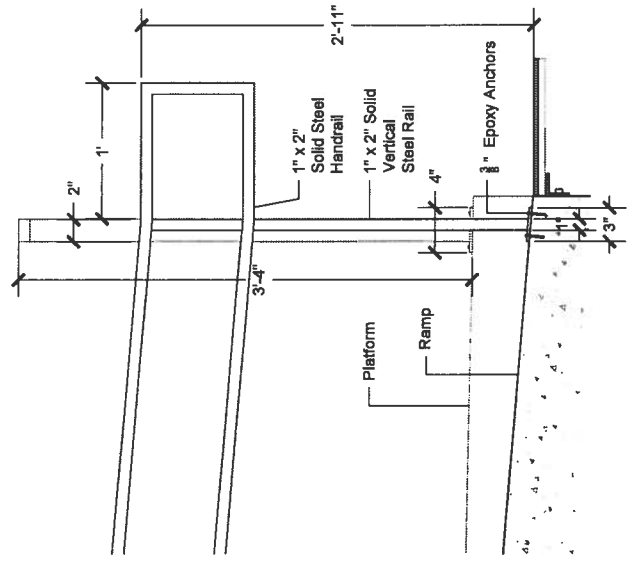

D Railing
SCALE: 1-1/2" = 1'-0"

Scale: Varies

Custom Railing & Lighting Pole Details

Downtown Menlo Park
Santa Cruz Ave. Street Cafes

402 15-07

Metal Drain Panel

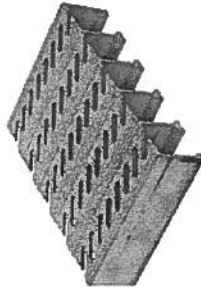

Perforated non-slip ADA Plank over gutters

Metal Railing

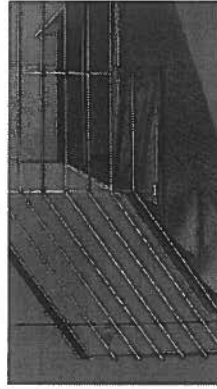

Architectural cable
Wood cap

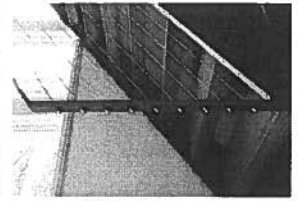

Stamped Concrete Platform Surface

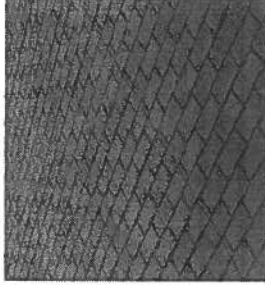

Running Bond Brick





EXHIBIT B - INVOICE

INVOICE

RETURN ONE COPY OF THIS INVOICE WITH YOUR REMITTANCE

PAYABLE UPON RECEIPT

Make all checks payable to:

City of Menlo Park/Transportation Division
701 Laurel Street
Menlo Park, CA 94025

Invoice to:

Left Bank Menlo Park Brasserie
635 Santa Cruz Avenue
Menlo Park, CA 94025

Date: 9/23/2016
Department: Public Works
Phone: 650-330-6740

Description

20% of the contract amount for the project: Santa Cruz Street Café Project: Bistro Vida Harvest - Left Bank

Left Bank Menlo Park Brasserie
Total Construction Cost Estimate
20% Owner responsibility

\$85,858.10
\$17,171.62

Total Due \$17,171.62

Left Bank

Additional Improvements

- Planter Box treatments to match business frontage facade
- Shrubs planted in planter boxes
- Outdoor Canopy Structure as pictured or city approved equivalent
- String LED lighting and propane heaters
- Outdoor furniture as pictured or city approved equivalent.

